

Spring Centralised, Manually Operated Supply sealed mid - position

ZM/1714/687

Type : 5/3
 Port Size : G1/2
 Operating Pressure : 2 - 10 bar
 Operating Temperature : 0°C to +80°C

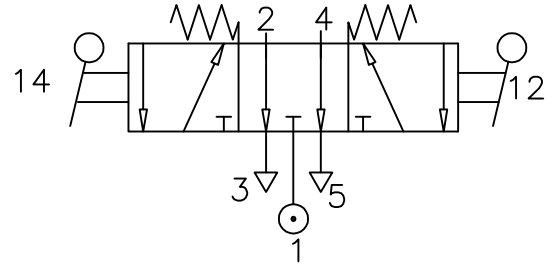

MATERIAL OF CONSTRUCTION

Body : Aluminium
 Seals : Nitrile

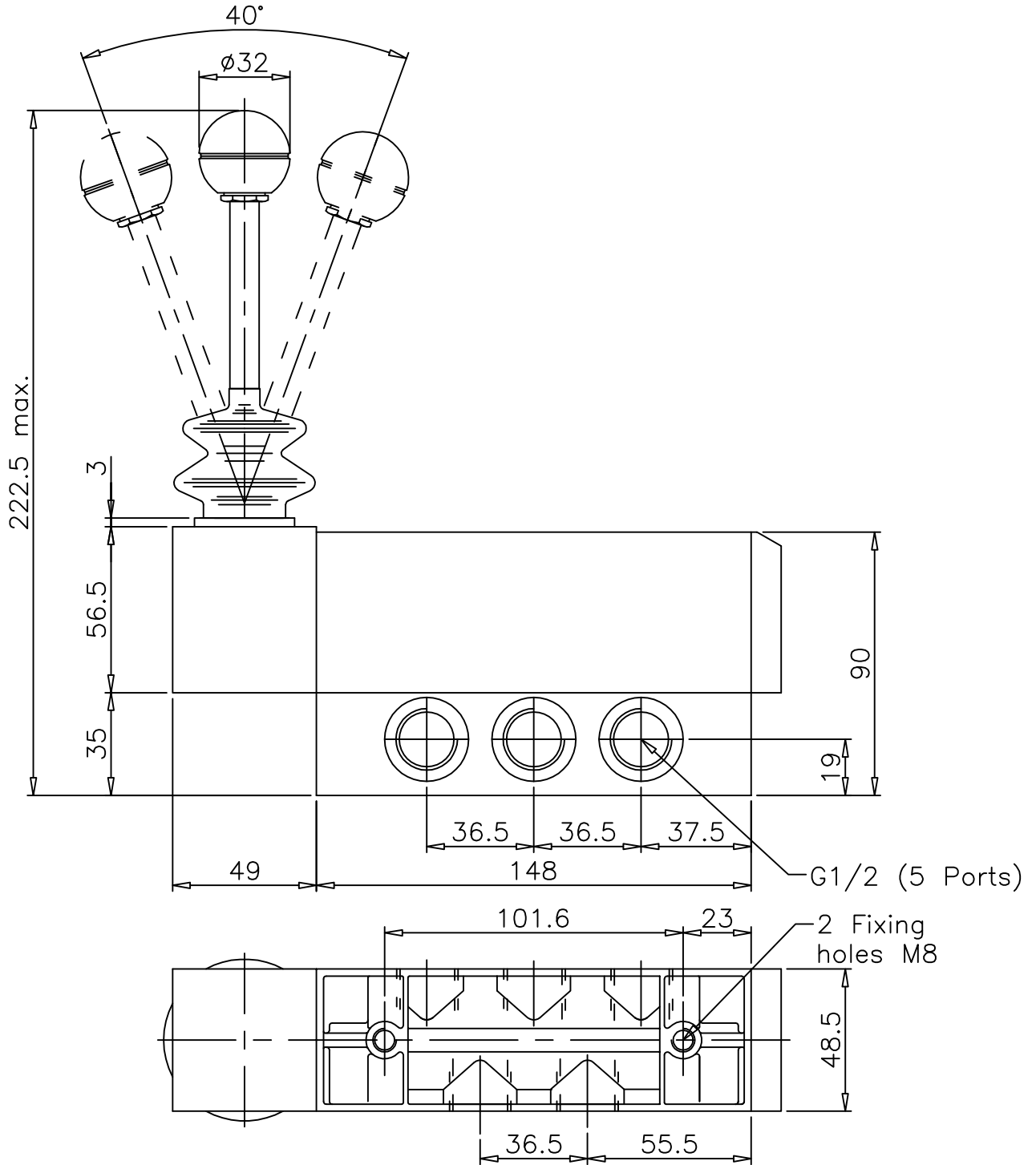

ALL DIMENSIONS ARE IN mm

NUCON INDUSTRIES PRIVATE LIMITED
 88 , C.I.E , BALANAGAR ,
 HYDERABAD - 500 037

DRAWN	T.Prabhakar	06.09.2008
CHECKED		
APPROVED		