

G1/4, 3/2 PILOT OPERATED, SPRING RETURN VALVE

ZNIV320PS

TECHNICAL SPECIFICATIONS

Medium	: Compressed air
Operating pressure	: 1.5 - 8 bar
Operating temperature	: + 50°C
Flow Cv	: 0.89

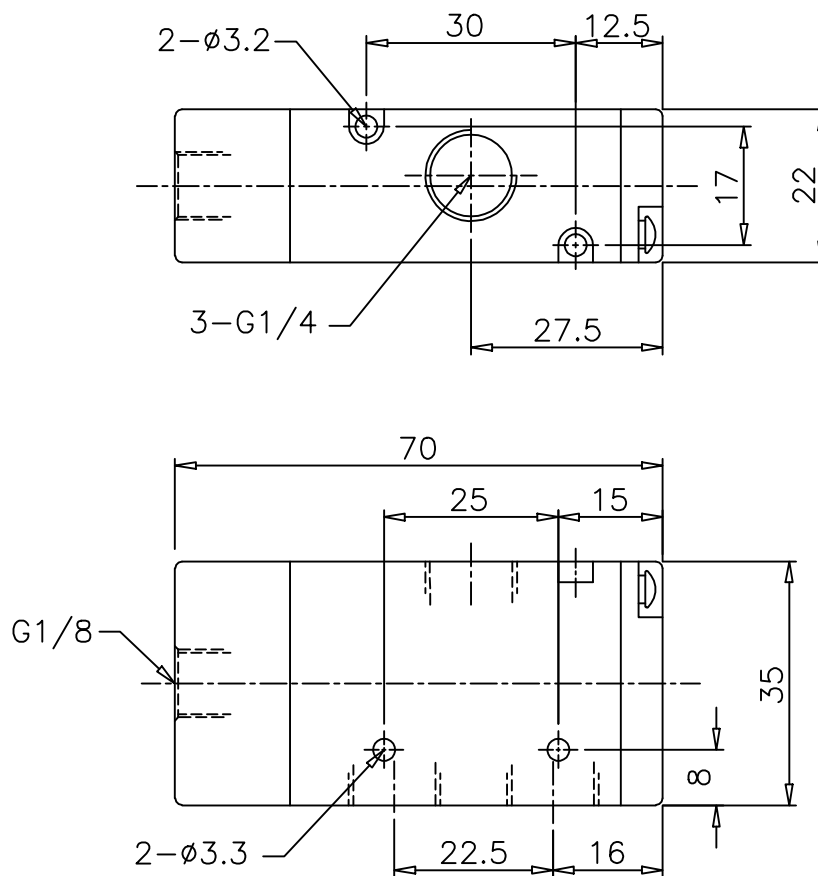
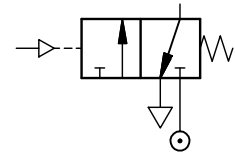

ALL DIMENSIONS ARE IN mm

NUCON INDUSTRIES PRIVATE LIMITED
88, C.I.E , BALANAGAR ,
HYDERABAD - 500 037

DRAWN	T.Prabhakar	07.05.2009
CHECKED		
APPROVED		