

# G1/4, 5/2 PILOT OPERATED, SET - RESET VALVE

## ZNIV520PP

### TECHNICAL SPECIFICATIONS

**Medium** : Compressed air  
**Operating pressure** : 1.5 - 8 bar  
**Operating temperature** : + 50°C  
**Flow Cv** : 0.89

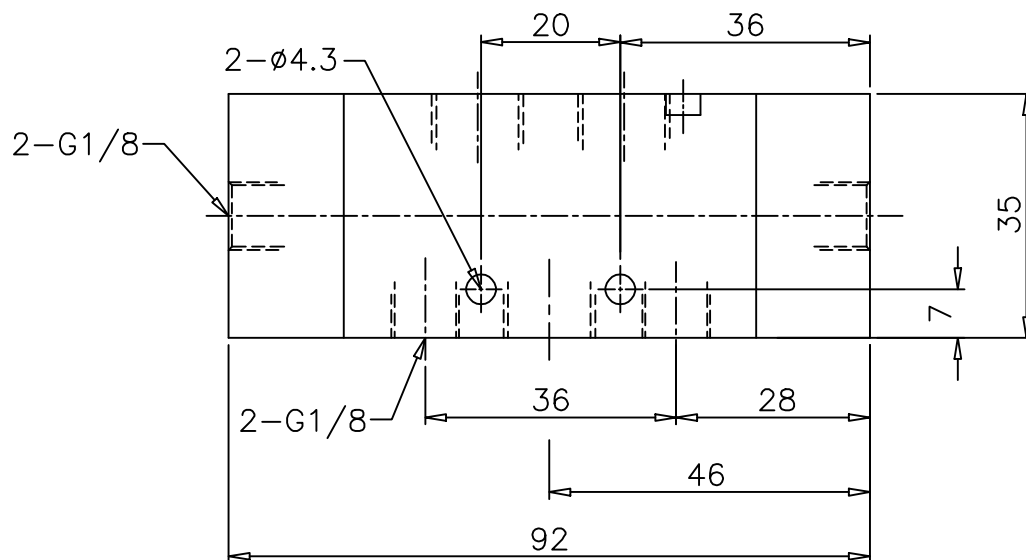
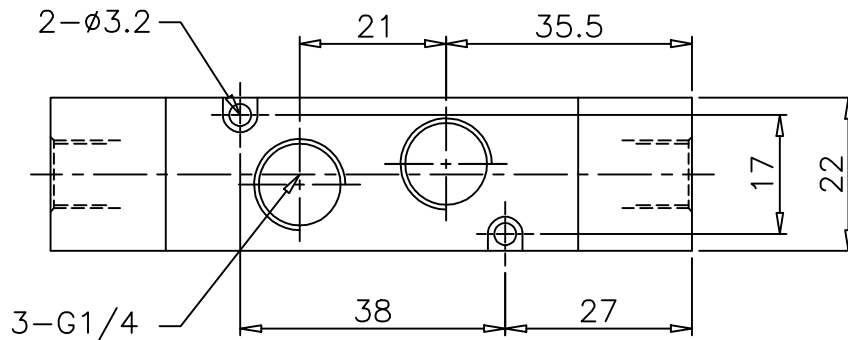
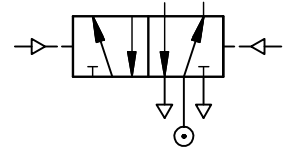

ALL DIMENSIONS ARE IN mm

NUCON INDUSTRIES PRIVATE LIMITED  
 88, C.I.E , BALANAGAR ,  
 HYDERABAD - 500 037

DRAWN	T.Prabhakar	07.05.2009
CHECKED		
APPROVED		