

REVISIONS

SCHEDULES: ZNRM/8040/50

ALL DIMENSIONS ARE IN mm
DO NOT SCALE THE DRAWING

DRG.No.
ZNRM/8040/50

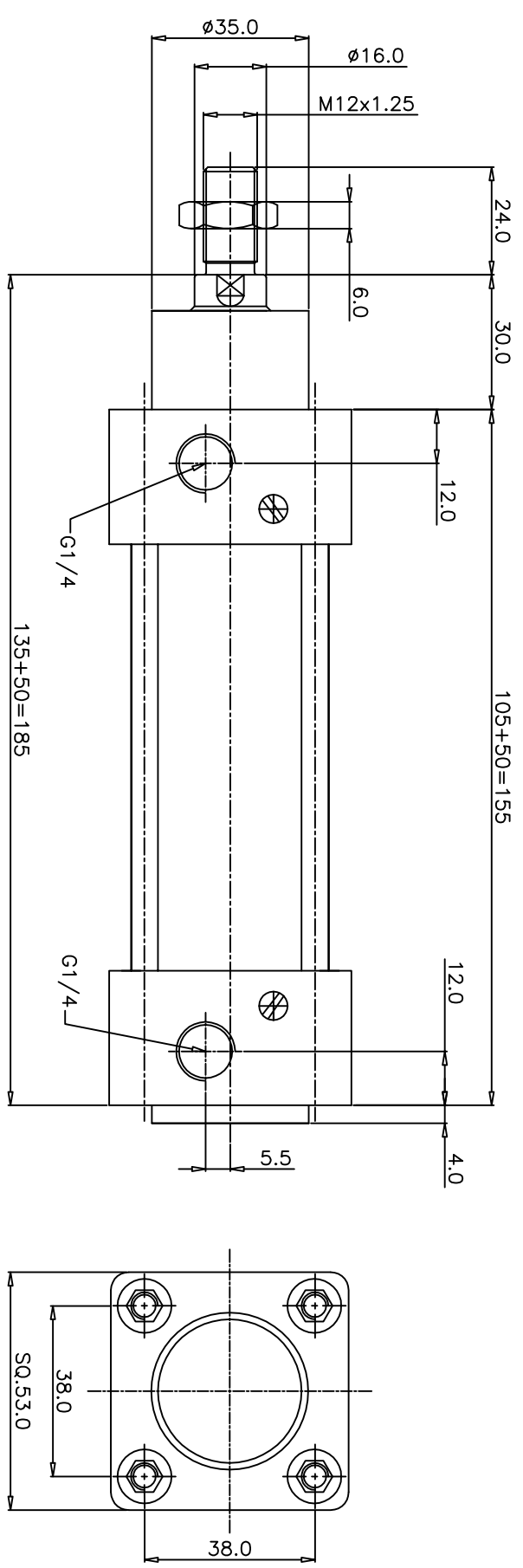

REMOVE BURRS AND SHARP CORNERS

NUCON INDUSTRIES PRIVATE LIMITED

ASSEMBLY: 40mm BORE 50mm STROKE STD. CYLINDER

SCALE: 1:1 TITLE: DATA SHEET

DRAWN	V.VINAY	28.08.2008
CHECKED		
APPROVED		
DRG.No.	ZNRM/8040/50	
SHEET		OF