

LEVER OPERATED, SPRING RETURN

ZX3 0478 02

Type : 5/2 Spool Valve
 Manually operated
 Port Size : G 1/8
 Operating Pressure : 2-10 bar
 Operating Temperature : +5°C to +70°C

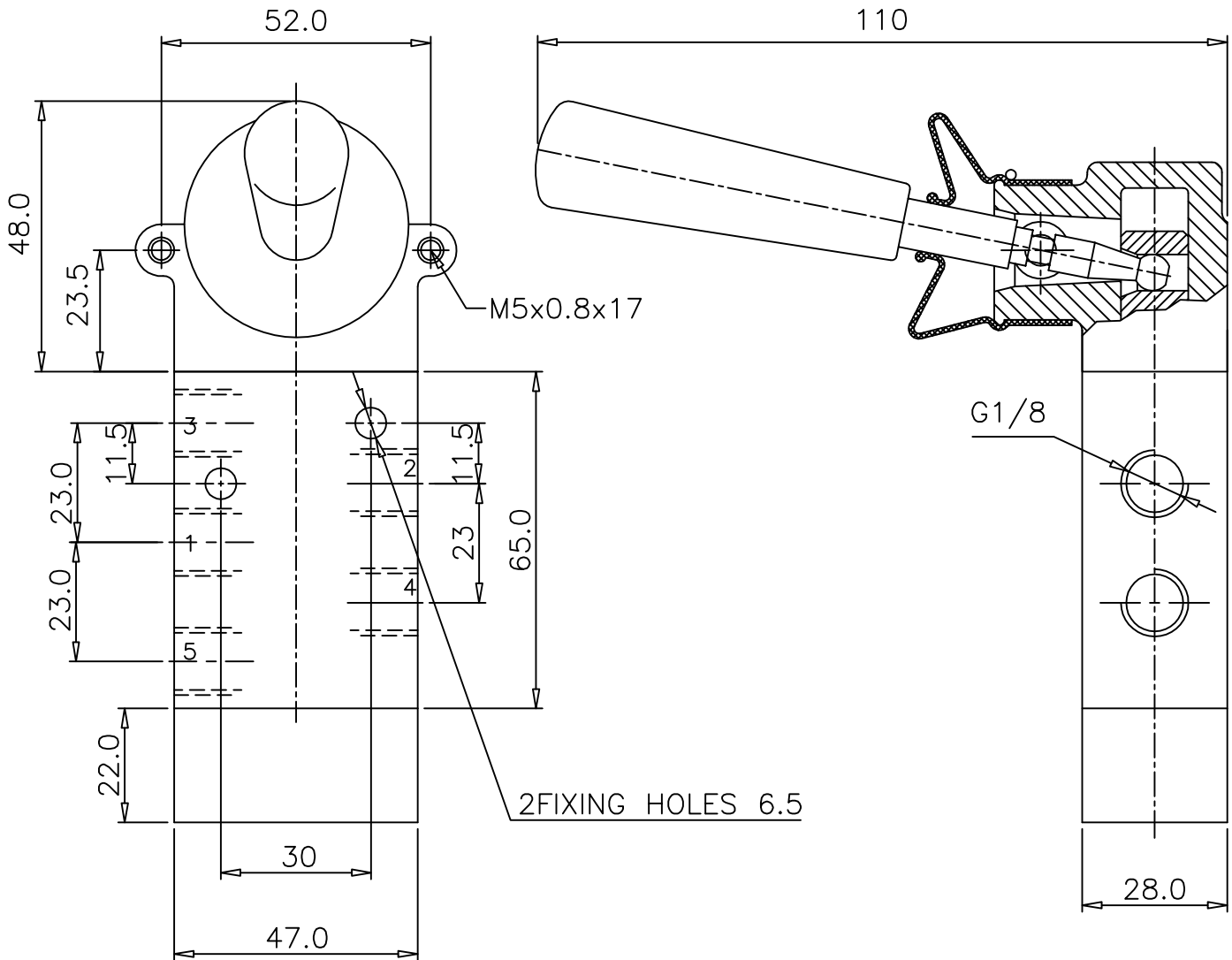
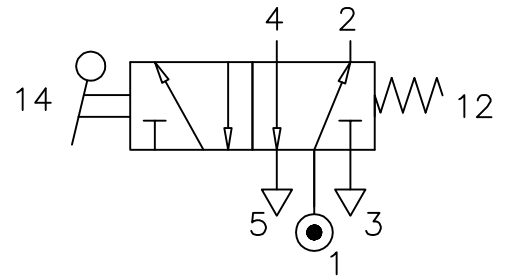

ALL DIMENSIONS ARE IN mm

NUCON ZANDER PRIVATE LIMITED
 88 , C.I.E , BALANAGAR ,
 HYDERABAD - 500 037

DRAWN	SREENIVAS.M	11.05.2005
CHECKED		
APPROVED		