

SPRING CENTRALIZED , LEVER OPERATED

ZX3 3478 02

Type : 5/3 Supply sealed
 Mid-position
 Port Size : G 1/8
 Operating Pressure : 0-10 bar
 Operating Temperature : +5°C to +70°C

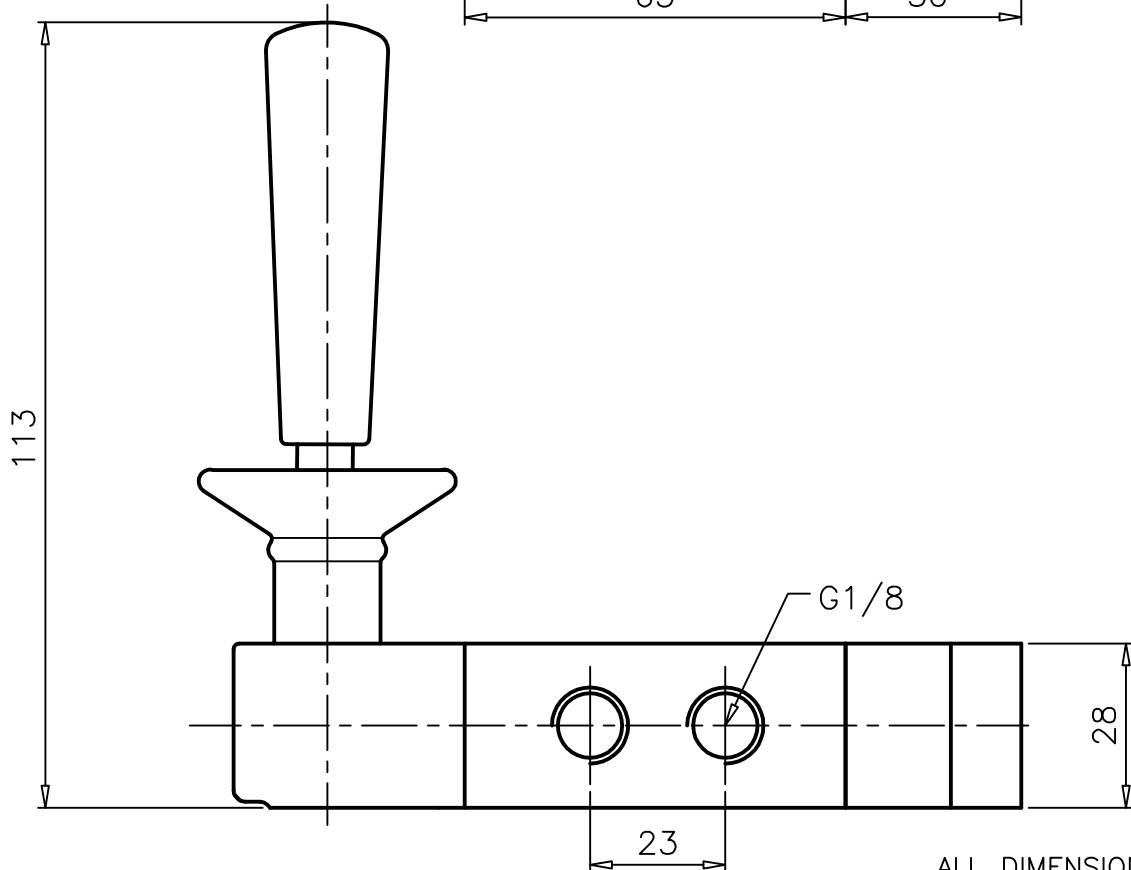
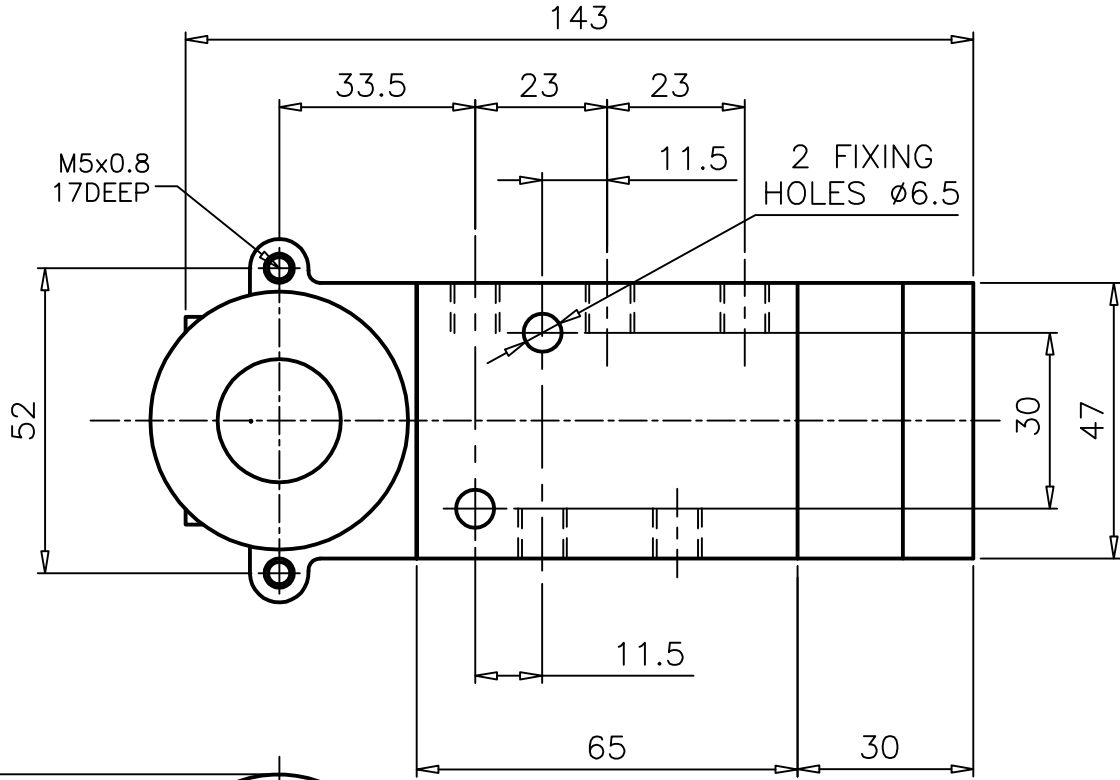
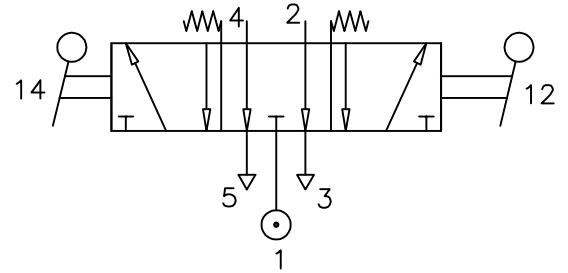

ALL DIMENSIONS ARE IN mm

NUCON ZANDER PRIVATE LIMITED
 88 , C.I.E , BALANAGAR ,
 HYDERABAD - 500 037

DRAWN	SREENIVAS.M	11.05.2005
CHECKED		
APPROVED		